

PROJECT NAME: \_\_\_\_\_ DATE: \_\_\_\_\_  
 CATALOG#: \_\_\_\_\_ TYPE: \_\_\_\_\_



Dalume - 1" Continuum Recessed, InGrade Floor & Surface

# 1" Continuum Linear LED Recessed, InGrade & Surface

## APPLICATION

Indoor damp or dry locations only. Ideal for Modern minimalist spaces including Education, Retail Office Residential, and Hospitality.

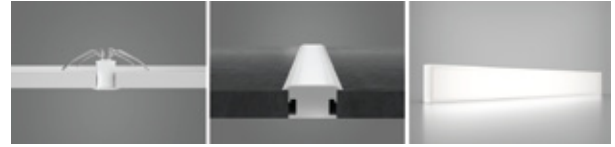

## DESCRIPTION

Slim and sleek LED system features low profile aluminum extrusion with white diffusing lens to deliver a pure shadow-free hotspot-free channel of light.

## RECESSED MOUNTING

The **(RV)** system may be secured directly into surfaces up to 1" inch thick with tool-free mounting clips for ease of installation and maintenance in New or Remodel Construction. Must allow 3" spacing with any type of insulation.

## INGRADE FLOOR MOUNTING

Equipped with heavy duty polycarbonate lens for Walkover applications, where **(FL)** luminarie may be between wood planks, concrete or cermaic flooring. Contact factory for wet location options.

## SURFACE MOUNTING

Equipped with screw in mounting clips onto any Structural surface **(S)**.

## PERFORMANCE/OPTICS

3 LED lumen output packages available for various applications and multiple Color Temperature options. LED boards are protected from environmental dust and moister with white snap-in lens.

## REMOTE POWER SUPPLY

120-277V, or 347V input, 120V/277V MLV, 0-10V, DALI dimming protocols. Surface mount remote electrical enclosure with multiple knockouts & removable access plate for maintenance. Pre-wired In/Out wiring terminals for clean and easy installation. Recommended 75' or less distance to luminaire with 16 AWG wire. See Power Source Specifications for longer distances and other details. Factory will supply a predetermined number of drivers & enclosures to power the entire system. For Individual or Specially Grouped driver/enclosure wiring, please specify Qty of DEJ101 and/or DEJ401 required. For recessed enclosure, consult factory.

## FINISHES

Standard interior color white. (Semi Gloss: Cardinal T007-WH121/RAL9003) white. For custom RAL colors **(CC)** are available, please specify RAL# or Cardinal Paint#

**LISTING** ETL /cETL listed to UL Standards for dry or damp locations.

**WARRANTY** 5-year factory warranty.

**Made to order in USA.**

### 1" Recessed Profile

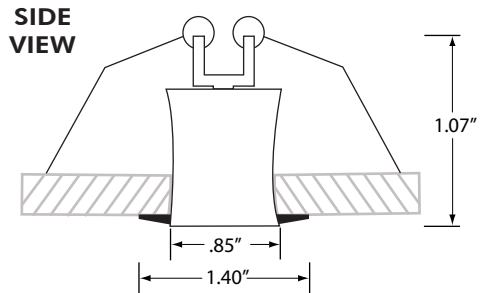

### 1" InGrade Profile

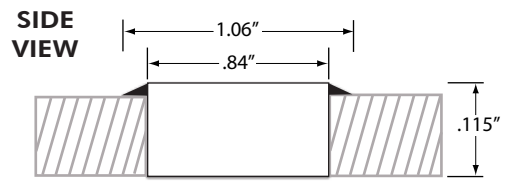

### 1" Surface Profile

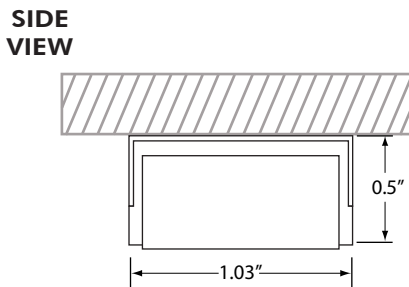

2022.10.28

## Ordering:

Example: DCR-8-4W-30K-S-UD

Ordering	Channel Length	Lumen Package per Ft.	COLOR TEMP	MOUNTING	REMOTE DRIVER	OPTIONS
DCR	1: 1 Ft. 2: 2 Ft. 4: 4 Ft. 8: 8 Ft. _:X Ft.	-4W: -9W: -12W:	-AMB: Warm Amber* <sup>1,3</sup> -27K: Incandescent White* <sup>1,3</sup> -30K: Warm White* <sup>1</sup> -35K: Neutral White -40K: Cool White -RGBW: Color Changing* <sup>1,3</sup>	-RV: Recessed Flange -S: Surface Mount -FL: InGrade Floor Mount -STRT: Surface/Strut Mount	-UD: 0-10V (120/277V) <sup>2</sup> -MLV: 120V Dim <sup>1,3</sup> -34V: 347V -DL: DALI	-CC: Custom Color* -EM: EM Back-Up <sup>2,4</sup>

<sup>1</sup> Consult for pricing.

<sup>2</sup> Consult factory if one Driver per fixture/Circuit wiring is required. Otherwise the factory will supply a predetermined number of Drivers to power the entire System.

<sup>3</sup> 12W per ft not available.

<sup>4</sup> Not available for MLV Drivers

\* Special order item, extended lead times may apply. Consult factory.

X- Specify channel length to 2" increments as to foot decimals. Example: 4" length to be 0.33.



Specifications subject to change without notice

www.dalume.com - DALUME®

# 1" Continuum Linear LED - Recessed, InGrade & Surface

## RECESSED MOUNT (RV)

### PERFORMANCE

IES INDOOR REPORT TOTAL RATED LUMENS 1090  
 DCR1-12-35K.IES

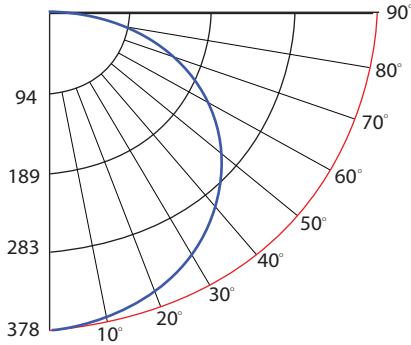

### LUMINANCE DATA (cd/sq.m)

Angle In Degrees	Ave rage 0-Deg	Ave rage 45-Deg	Ave rage 90-Deg
45	50400	40985	38233
55	48270	36389	33237
65	46219	31096	27615
75	44358	24219	20613
85	48504	14487	11405

### ZONAL LUMEN SUMMARY

Zone	Lumens	%Lamp	%Fixt
0-30	287.18	26.3	26.4
0-40	465.09	42.7	42.7
0-60	812.06	74.5	74.5
0-90	1060.05	97.3	97.3
90-120	15.93	1.5	1.5
90-130	19.84	1.8	1.8
90-150	26.23	2.4	1.8
90-180	29.62	2.7	2.7
0-180	1089.67	100	100

### ZONAL LUMEN SUMMARY

Zone	Lumens
0-10	35.65
10-20	101.01
20-30	150.51
30-40	177.91
40-50	182.18
50-60	164.8
60-70	129.71
70-80	82.92
80-90	35.36
90-100	8.94
100-110	3.34
110-120	3.65
120-130	3.91
130-140	3.57
140-150	2.83
150-160	1.92
160-170	1.08
170-180	.38

## RECESSED SPACKLE FLANGE (RS)

### PERFORMANCE

IES INDOOR REPORT TOTAL RATED LUMENS 900/Ft. @12W  
 DCR1-12W-35K-RS-UD.IES

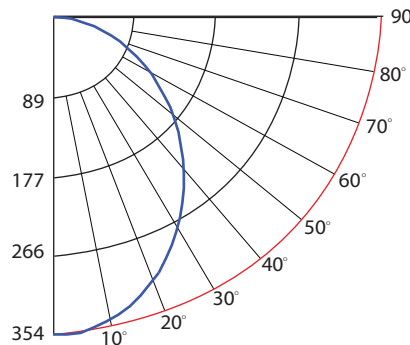

### LUMINANCE DATA (cd/sq.m)

Angle In Degrees	Ave rage 0-Deg	Ave rage 45-Deg	Ave rage 90-Deg
45	35694	35694	35694
55	33028	33028	33028
65	30431	30431	30431
75	27708	27708	27708
85	29432	29432	29432

### CONE CHART

Height (FT)	Beam Diameter	Foot Candle
8.0'	19.1'	5.5
9.0'	21.5'	4.4
10.0'	23.9'	3.5
12.0'	28.7'	2.5
14.0'	33.4'	1.8

### Lumens Multiplier Table

	4W/ Ft	9W/ Ft	12W/ Ft
3000K	358	625	980
3500K	372	650	1020
4000K	388	677	1063

## SURFACE MOUNT (S)

### PERFORMANCE

IES INDOOR REPORT TOTAL RATED LUMENS 833  
 DCR1-12-35K.IES

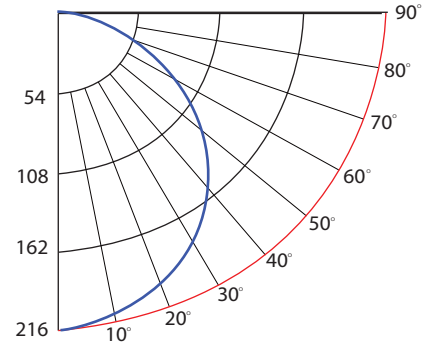

### LUMINANCE DATA (cd/sq.m)

Angle In Degrees	Ave rage 0-Deg	Ave rage 45-Deg	Ave rage 90-Deg
45	57798	47183	44218
55	54772	41400	37932
65	51089	34419	30591
75	46008	24933	20973
85	36629	10788	8123

### ZONAL LUMEN SUMMARY

Zone	Lumens	%Lamp	%Fixt
0-30	233.15	28	28
0-40	377.73	45.3	45.3
0-60	656.16	78.8	78.7
0-90	833.12	100	99.9
90-120	.67	.1	.1
90-130	.69	.1	.1
90-150	.72	.1	.1
90-180	.74	.1	.1
0-180	833.86	100.1	100

### ZONAL LUMEN SUMMARY

Zone	Lumens
0-10	28.85
10-20	81.97
20-30	122.33
30-40	144.58
40-50	147.15
50-60	131.29
60-70	100.33
70-80	59.01
80-90	17.62
90-100	.63
100-110	.02
110-120	.02
120-130	.02
130-140	.02
140-150	.01
150-160	.01
160-170	.01
170-180	0

2022.10.28

PROJECT NAME: \_\_\_\_\_ DATE: \_\_\_\_\_  
 CATALOG#: \_\_\_\_\_ TYPE: \_\_\_\_\_

# 1" Continuum Recessed, Ingrade Floor & Surface

## POWER SUPPLY SPECIFICATIONS

Surface mount remote electrical enclosure with input and output knock-outs and removable access plate for maintenance. Prewired Input and Output wiring terminals for clean and easy installation. Total weight 6 to 12lbs.

## ELECTRICAL BOX SPECS

Remote LED Dimmable Drivers are class 2 rated and customly configured to operate with Dalume's 1" & 2" Continuum series lighting package. All Drivers equipped with Over voltage, Over temperature & Overload protection plus short circuit protection per UL8750.

For standard wiring please reference wiring diagram, for special circuit wiring, contact factory. Contact Factory for driver/wiring details.

## 0-10V ANALOG DIMMING

120-277V 50 - 60 (Hz) input, 1% dimming. -40 C to 45 C Operating Temp. EMI and RFI; Meets FCC part 15 (Class A)

## 120V/277V, MLV/INCANDESCENT 3WIRE DIMMING

120V 50Hz or 277V 60Hz input. -20 C to 45 C Operating Temp. For RGBW, DALI specifications, contact Factory. 1/2"

## DEJ10

1 Driver Capacity / 1 Circuit Remote Enclosure:  
 Wall mount design includes removable covers fastened with plated steel screws with a unpainted 20 ga. steel finish. Knockouts included: (2)1" K.O's

## DEJ40

2-4 Driver Capacity / 2-4 Circuit Remote Enclosure:  
 NEMA 1 removable covers fastened with plated steel screws with a unpainted 16ga. steel enclos finish.  
 Knockouts included: (6) x 1/2" to 3/4" K.O's, (2) 3/4"-1" K.O's

## WIRING DIAGRAM (Typical)

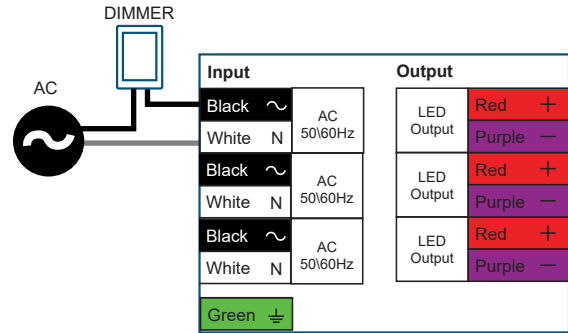

## DEJ101

TOP & SIDE VIEW

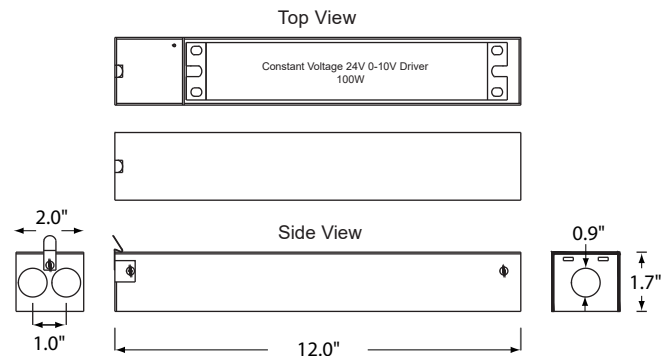

## DEJ401\*

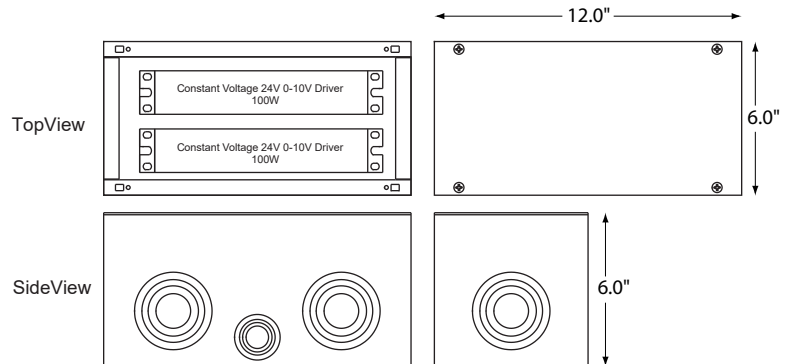

\* DEJ402, 6" Depth

## DROP VOLTAGE CHART

Total Nominal Wattage of Driver	Maximum Cable Length (feet) at Full Load		
	12 Gauge	14 Gauge	16 Gauge
45W	N/A	N/A	100'
120W	125'	100'	75'
200W	100'	75'	Do Not Use
300W	75'	Do Not Use	Do Not Use

2022.10.28